

### Article Réf. 395 Chariot au sol avec 5 roulettes

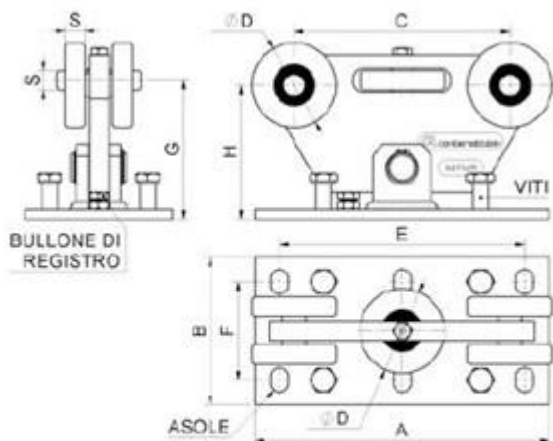

mm.	A	B	C	ØD	E	F	G	H	S	Asole	Viti	Bullone
Petit	180	150	135	Ø59,5	125	100	100	100	15	n.4 18x25	--	M8
Moyen	300	150	220	Ø86	250	100	140	135	20	n.6 18x25	M16x35	M12
Grand	500	200	380	Ø126	440	150	202	197	30	n.6 22x30	M16x35	M12

### Art réf. 9999 Chariot au sol avec 9 Roulettes

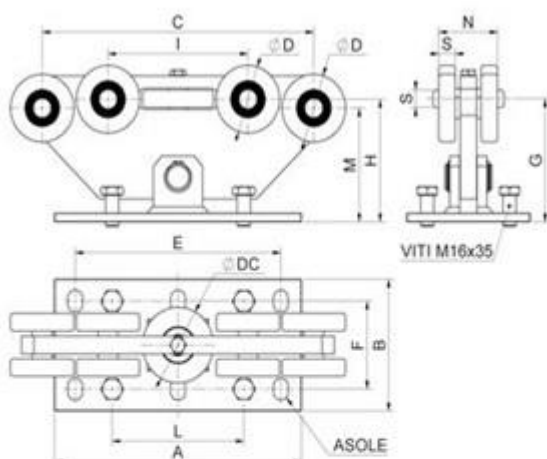

Cod.	mm.	A	B	C	ØD	ØDC	E	F	G	H	I	L	M	N	S	Asole	Viti	pz/pcs
9999.P	Petit	180	150	250	Ø59	Ø59	125	100	100	101	125	-	99	51,5	15	n.4 18x25	-	1
9999.M	Moyen	300	150	330	Ø77	Ø86	250	100	140	139,5	170	160	129,5	71,5	20	n.6 18x25	n.4 M16x35	1
9999.G	Grand	500	200	500	Ø117	Ø126	440	150	202	201,5	260	320	191,5	108,5	30	n.6 22x30	n.4 M16x35	1

Article Réf. 396 **Roulette de Réception**

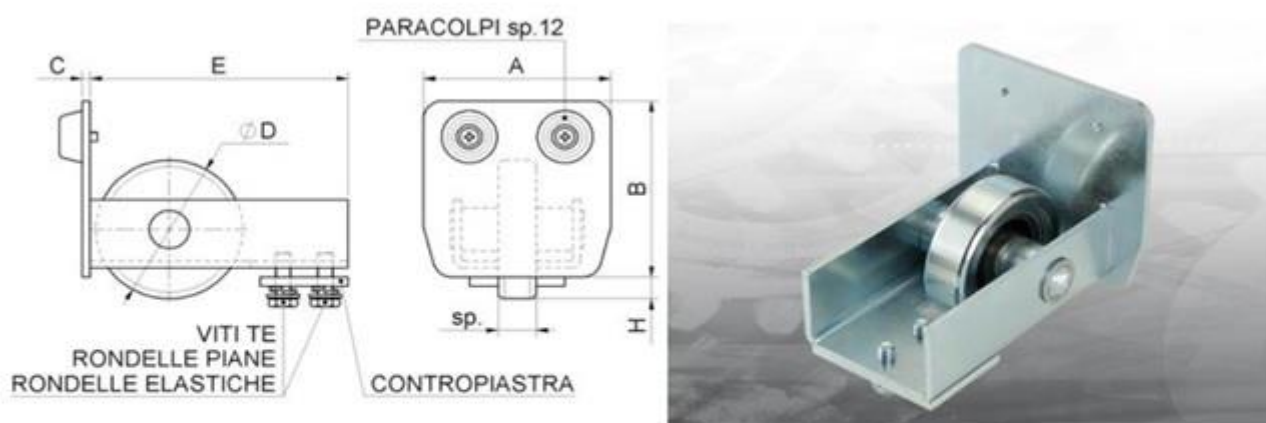

mm.	A	B	C	ØD	E	H	Sp.	Viti	Contropiastra	Paracolpi
Petite	67	67	4	Ø67	120	14,5	15	M8	50x46 sp.5	1
Moyenne	98	98	4	Ø77	135	12	20	M8	50x46 sp.5	2
Grande	140	140	5	Ø97	165	13,5	30	M10	90x60 sp.6	2

Article Réf. 396 **Roulette de Réception**

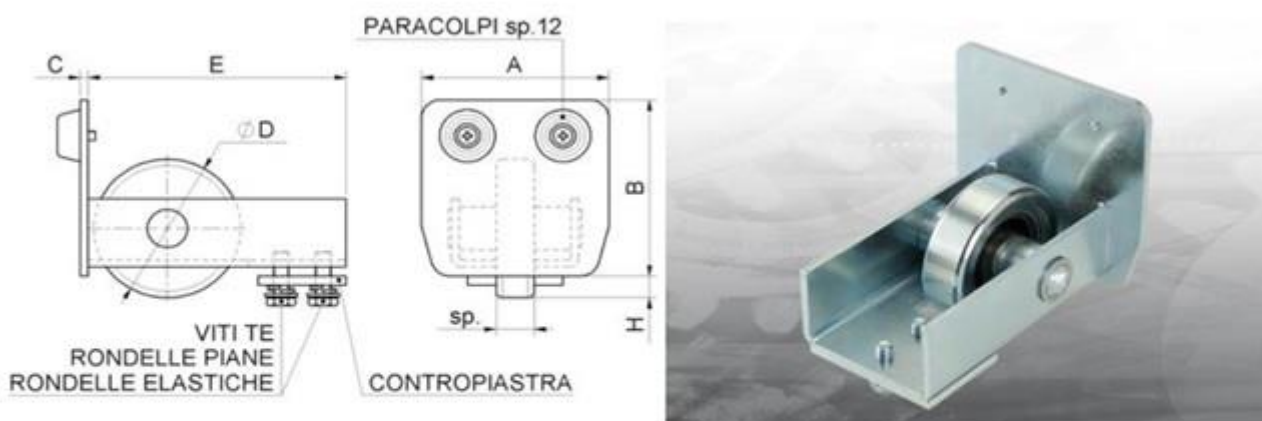

mm.	A	B	C	ØD	E	H	Sp.	Viti	Contropiastra	Paracolpi
Petite	67	67	4	Ø67	120	14,5	15	M8	50x46 sp.5	1
Moyenne	98	98	4	Ø77	135	12	20	M8	50x46 sp.5	2
Grande	140	140	5	Ø97	165	13,5	30	M10	90x60 sp.6	2

# FICHE TECHNIQUE



**Accessoire Portail Autoportant**

**ART.399.M – Rail de 6m (moyenne = 98mm)**

Article Réf. 399 **RAIL**

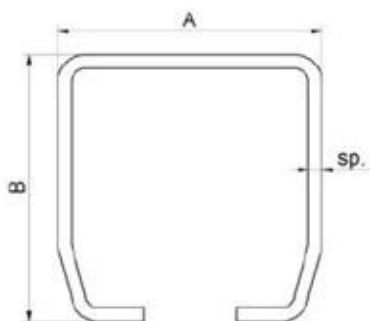

mm.	A	B	Ep.	Longueur	Longueur	Finition	Finition	Pcs.
Petite	67	67	3	3 m	6 m	Grezzo/Blank	Zincato/Zink	1
Moyenne	98	98	5	3 m	6 m	Grezzo/Blank	Zincato/Zink	1
Grande	140	140	6	3 m	6 m	Grezzo/Blank	Zincato/Zink	1

**Accessoire Portail Autoportant**

**ART.399.G – Rail de 6m (grande =140mm)**

Article Réf. 399 **RAIL**

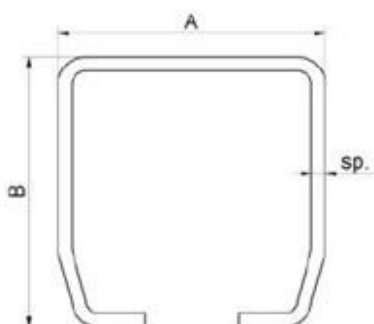

mm.	A	B	Ep.	Longueur	Longueur	Finition	Finition	Pcs.
Petite	67	67	3	3 m	6 m	Grezzo/Blank	Zincato/Zink	1
Moyenne	98	98	5	3 m	6 m	Grezzo/Blank	Zincato/Zink	1
Grande	140	140	6	3 m	6 m	Grezzo/Blank	Zincato/Zink	1

Article Réf. 462 **Platine de guidage supérieure ajustable**

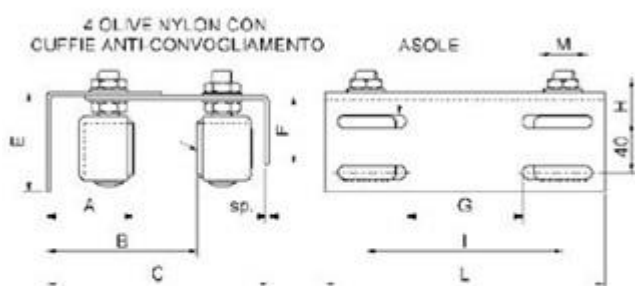

mm.	A	B	C	E	F	G	H	Asole	L	Sp	I	M	Olive
Petite	43-86	93-156	149-197	76	54	91	21	11x54	220	3	155	M14	Ø30x40
Moyenne	47-90	89-151	149-197	76	54	91	21	11x54	220	3	155	M16	Ø40x45
Grande	49-91	110-195	200-243	81	74	157	26	11x63	350	4	285	M16	Ø40x60